



ESTE PRODUCTO SE
SIRVE DESMONTADO



ENCLAVE EDUCATIVO
Equipamiento de Centros Escolares



CASITA ELFOS

Ref. 81231



www.mobiliario-escolar.es

Descripción Y Especificaciones

Edad de uso recomendada:

Para niños a partir de 1 año.

Espacio de caída:

Se recomienda 1,5 m alrededor.

Altura de caída libre:

≤ 0,60 m.

Dimensiones totales del conjunto:

Largo: 2,076 m; Alto: 1,517 m; Ancho: 1,231 m.

Peso aproximado del conjunto:

??? kg.

Descripción del juego:

Juego compacto con forma de casita.

Juego adaptado para los mas pequeños para el juego de roles y relaciones. En su interior contiene dos asientos.

Materiales:

Placas de HDPE de colores.

Fijación:

Mediante pernos de anclaje.



ESTE PRODUCTO SE SIRVE DESMONTADO

Funciones Lúdicas



Cobijo
Sentarse



Escondite
Protegido



Capacidad
1-5 uds.

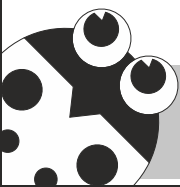

Casita Elfos

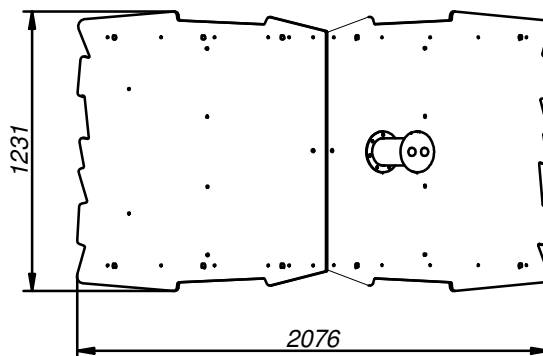
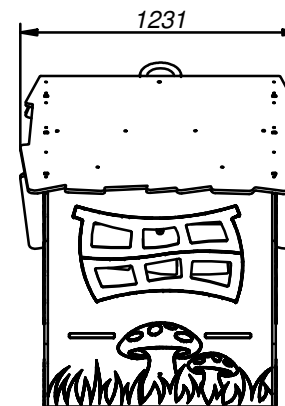
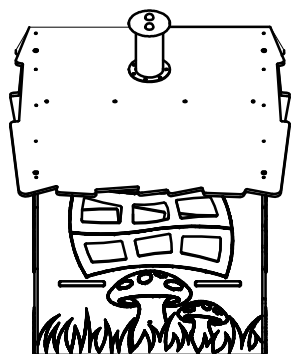

PLANO DE CIMENTACIÓN con suelo elastico

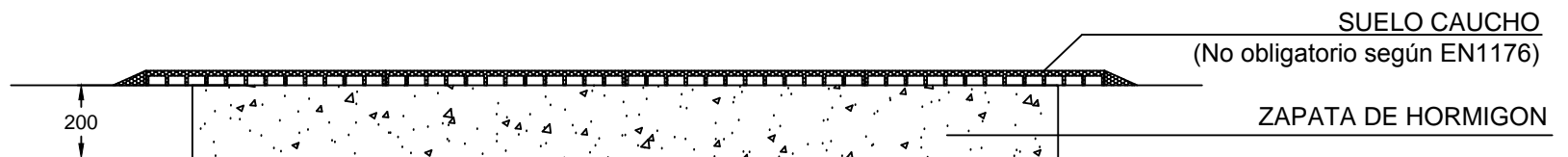
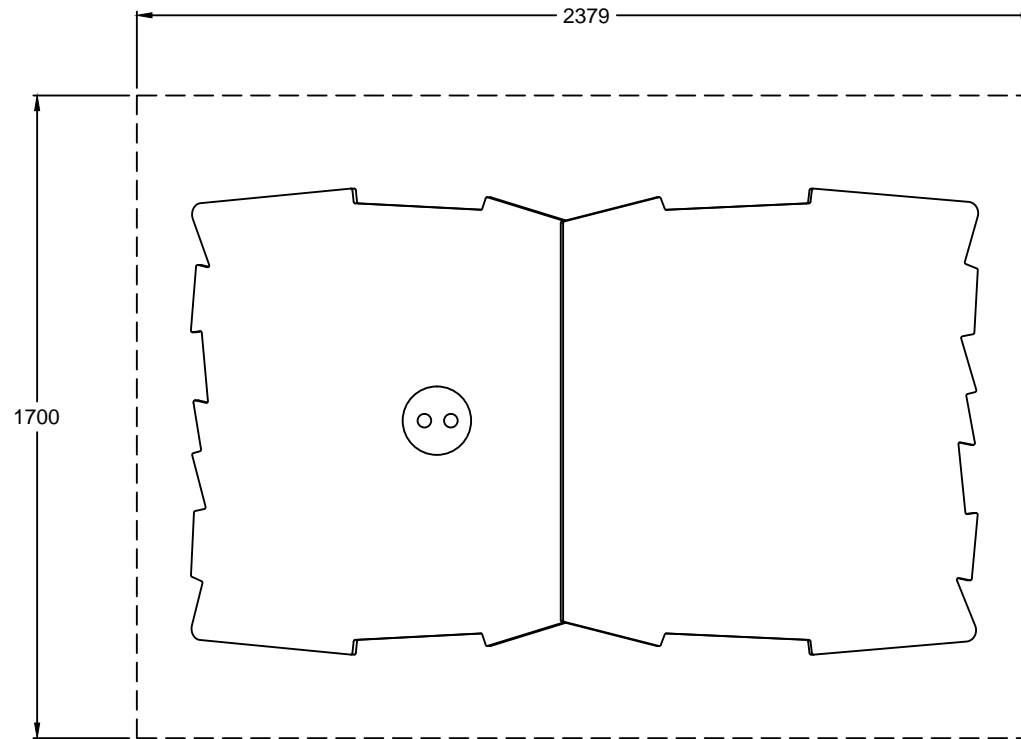

Anclaje con:
- 8 Tacos de expansión.

PLANO DE CIMENTACIÓN para arenero

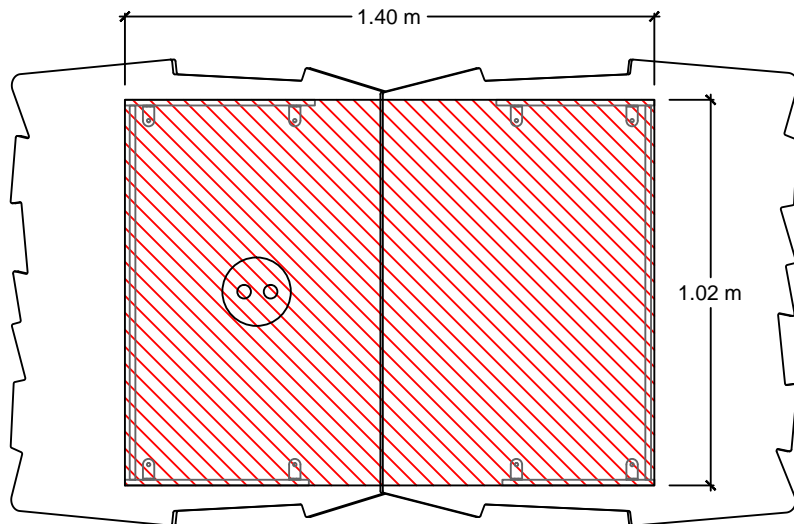
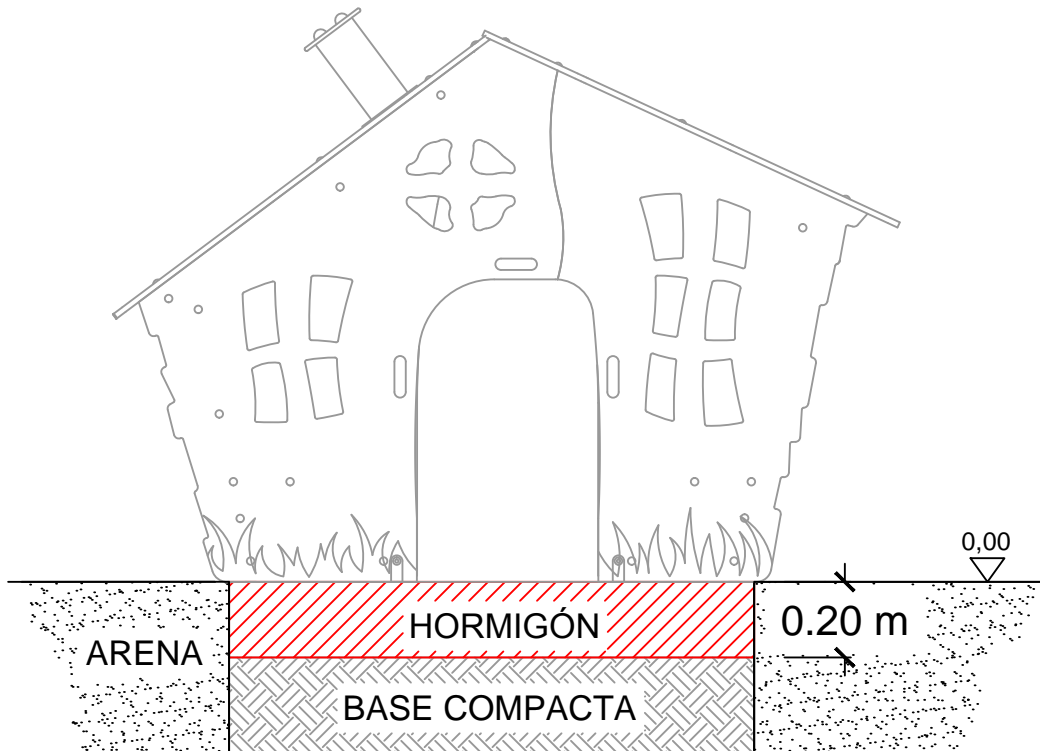

Anclaje con:
- 8 Tacos de expansión.



ENCLAVE EDUCATIVO
Equipamiento de Centros Escolares

INSTRUCCIONES DE MONTAJE
CASITA ELFOS
ref. 81231



80129 IM Casita ELFOS 05/04/2019

CASITA ELFOS

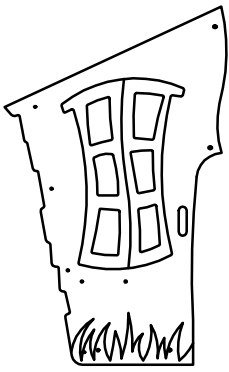

a
58122901
x1

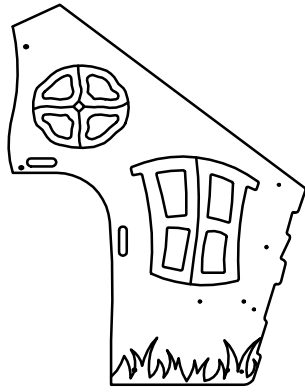

b
58122902
x1

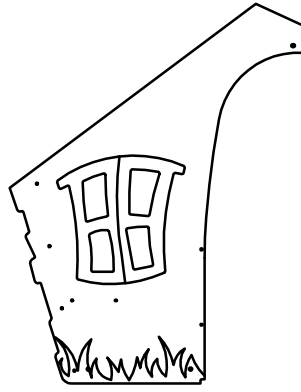

c
58122903
x1

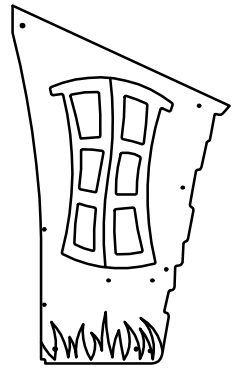

d
58122904
x1

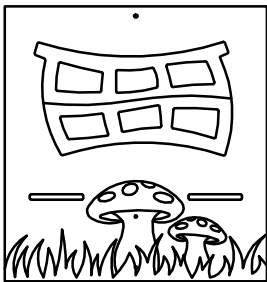

e
58122905
x1

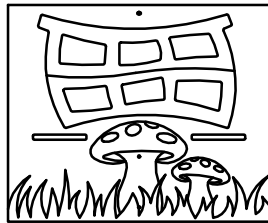

f
58122906
x1

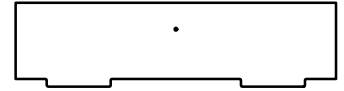

g
58122907
x2

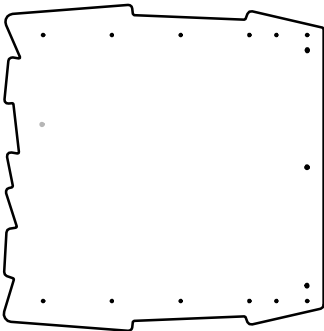

h
58122908
x1

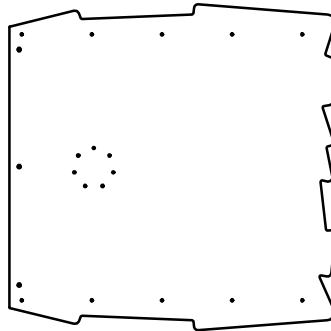

i
58122909
x1

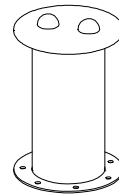

k
58122928
1x

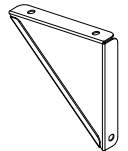

l
58122924
2x



m
50002109
3x



n
58067805
3x



o
58122925
8x



p
50002109
15x

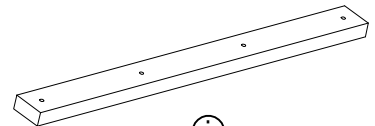

q
58122932
x2



r
Tuerca M8
20x



s
Arandela M8
10x



t
Tornillo M8x25
10x

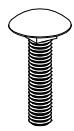

u
Tornillo M8x45
8x

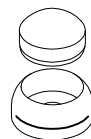

v
80337
10x

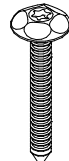

w
Tornillo torx M6x40
54x



x
77032300
8x

1

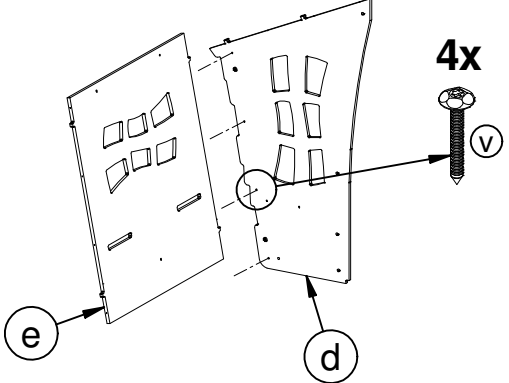

2

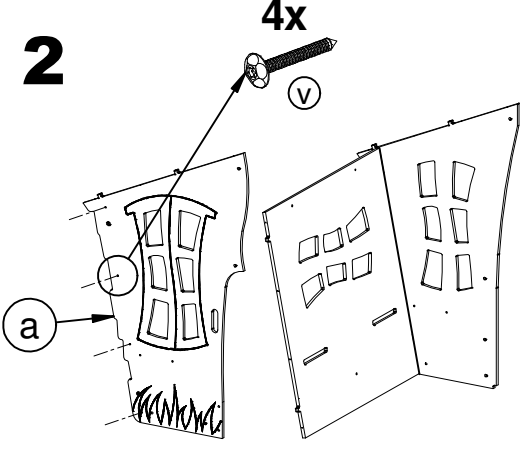

3

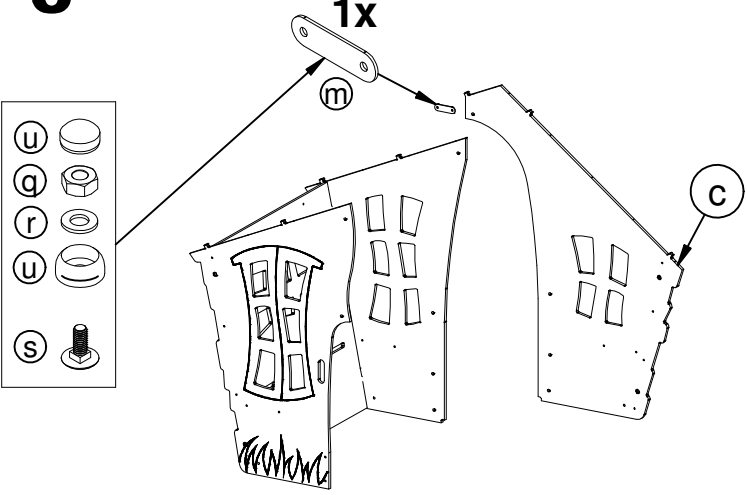

4

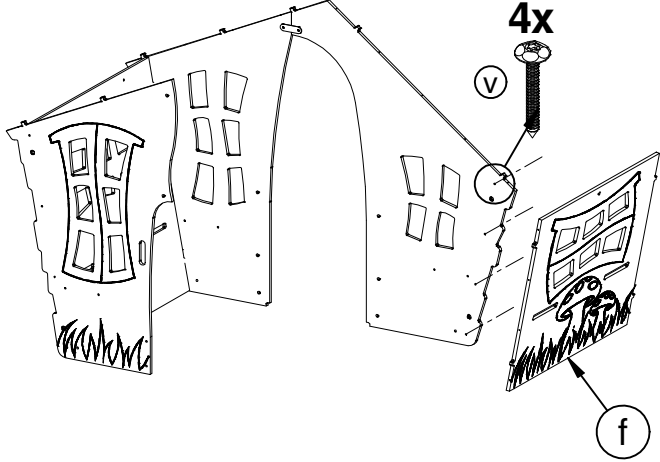

5

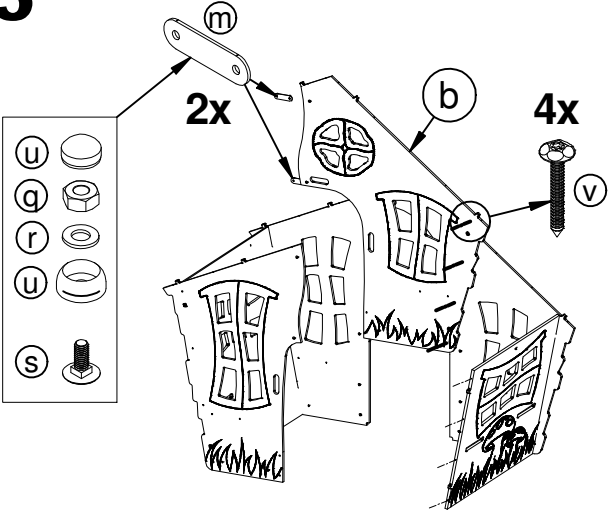

6

